

Technisches Datenblatt
 Technical Datasheet
 Art.-No. 82634

MAUL

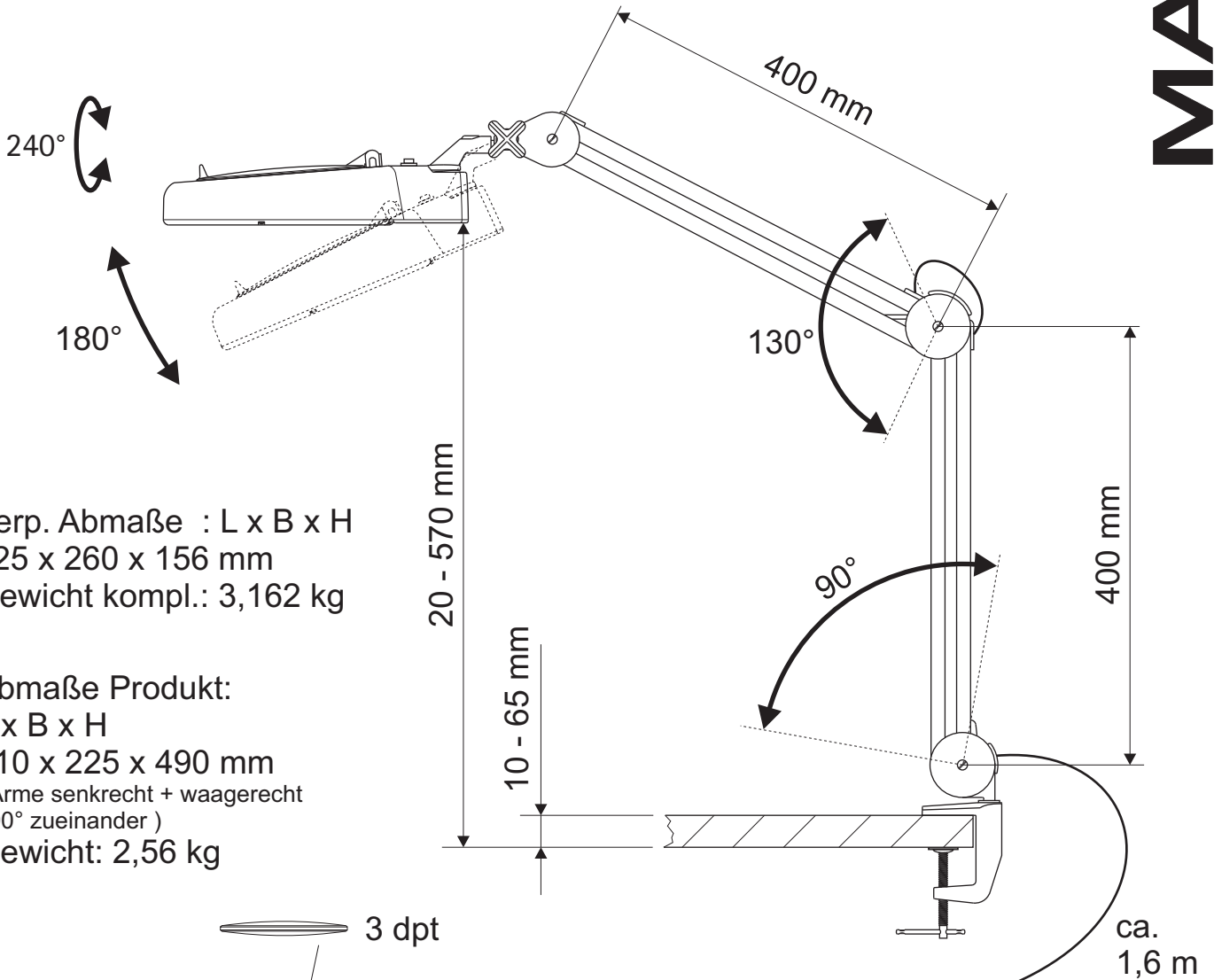

Verp. Abmaße : L x B x H
 525 x 260 x 156 mm
 Gewicht kompl.: 3,162 kg

Abmaße Produkt:
 L x B x H
 810 x 225 x 490 mm
 (Arme senkrecht + waagrecht
 90° zueinander)
 Gewicht: 2,56 kg

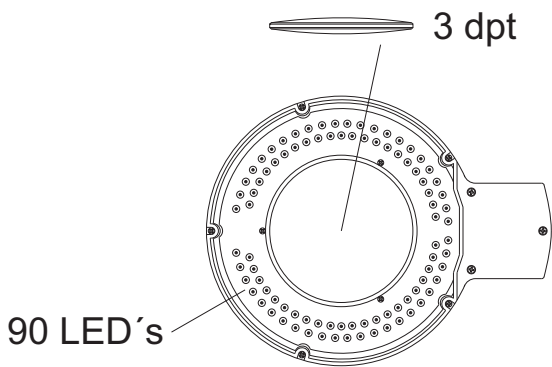

230V 50Hz

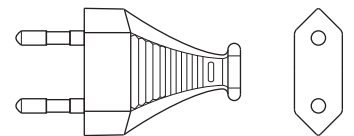

CEE 7/16

